

DIN 69871 A

DIN 69871 AD / B

**TECHNISCHE DATEN DER STEILKEGELWERKZEUGE
TAPER SHANKS DATA SHEET
DONNES TECHNIQUES QUEUE D'OUTILS
DATI TECNICI CONI D'ATTACCO**

DIN 69871/A

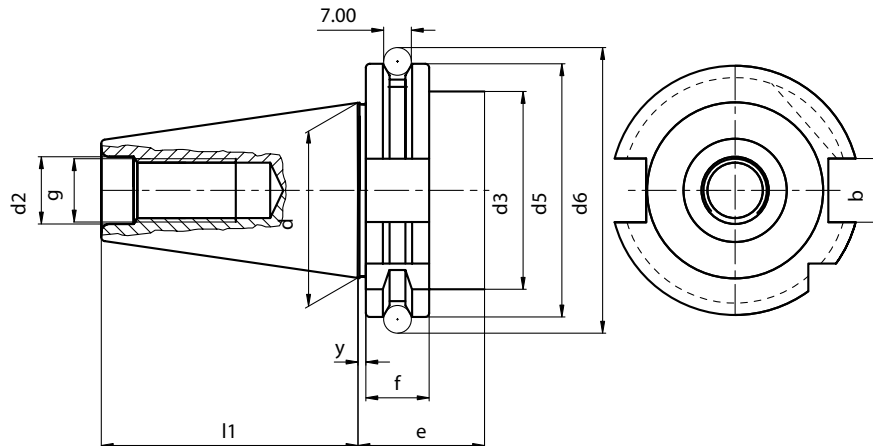

ISO	d	l1	d2	g	y	d5	f	d3	d6	e	b
30	31,75	47,8	13	M12	3,2	50	15,9	45	59,3	35	16,1
40	44,45	68,4	17	M16	3,2	63,55	15,9	50	72,3	35	16,1
50	69,85	101,75	25	M24	3,2	97,5	15,9	80	107,25	35	25,7

For coolant through the center of the toolholders with hollow retention knobs.
Il lubrificante passa dal centro del mandrino attraverso il tirante forato.

**TECHNISCHE DATEN DER STEILKEGELWERKZEUGE
TAPER SHANKS DATA SHEET
DONNES TECHNIQUES QUEUE D'OUTILS
DATI TECNICI CONI D'ATTACCO**

DIN 69871 AD/B

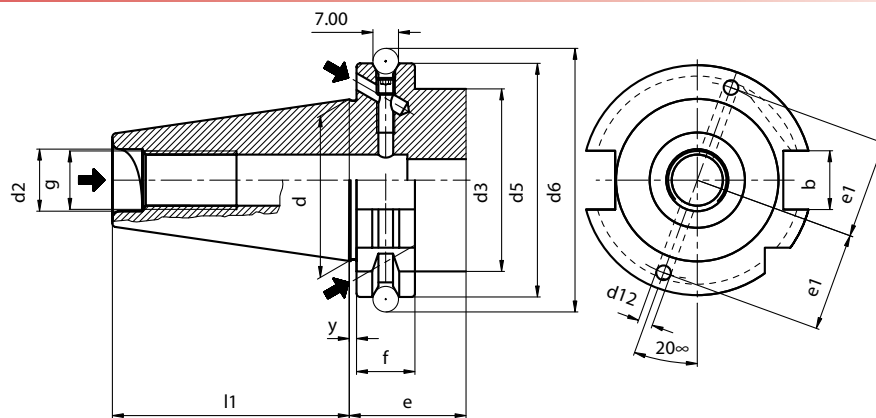

FORM AD

FORM B

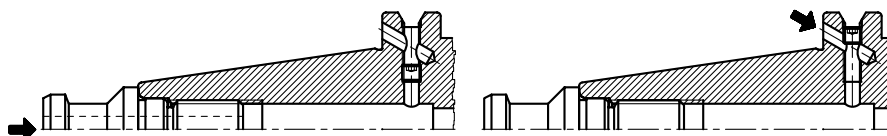

ISO	d	l1	d2	g	y	d5	f	d3	d6	e	b	d12	e1
40	44,45	68,4	17	M16	3,2	63,55	15,9	50	72,3	35	16,1	4	27
50	69,85	101,75	26	M24	3,2	97,5	15,9	80	107,25	35	25,7	5	42

For coolant through V-flange bores (B) or center of toolholders (AD). For central coolant, the V-flange channels are closed by socket screws.
Il lubrificante passa dai fori sulla flangia (B) oppure, chiudendo i fori con le apposite viti, dal centro del mandrino (AD).

ZYLINDERSCHAFTAUFNAHME WELDON
 END MILL HOLDERS WELDON
 MANDRINS POUR OUTIL TYPE WELDON
 MANDRINI PORTAFRESE TIPO WELDON

DIN 1835 B

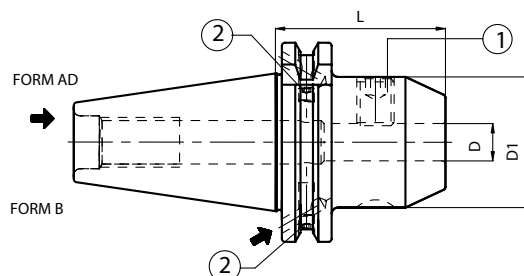

Code N.	Description	ISO	D	L	D1
*263-11201	TC30H45WE06	30	6	45	25
*263-11202	TC30H45WE08	30	8	45	28
*263-11203	TC30H50WE10	30	10	50	35
*263-11204	TC30H50WE12	30	12	50	42
*263-11205	TC30H70WE16	30	16	70	48
*263-11206	TC30H70WE20	30	20	70	52
213-11326	TC40H50WE06 AD+B	40	6	50	25
213-11327	TC40H50WE08 AD+B	40	8	50	28
213-11328	TC40H50WE10 AD+B	40	10	50	35
213-11329	TC40H50WE12 AD+B	40	12	50	42
213-11330	TC40H50WE14 AD+B	40	14	50	44
213-11324	TC40H63WE16 AD+B	40	16	63	48
213-11331	TC40H63WE18 AD+B	40	18	63	50
213-11325	TC40H63WE20 AD+B	40	20	63	52
213-11323	TC40H100WE25 AD+B	40	25	100	65
213-11332	TC40H100WE32 AD+B	40	32	100	72
213-11393	TC40H115WE40 AD+B	40	40	115	80
213-11333	TC50H63WE06 AD+B	50	6	63	25
213-11334	TC50H63WE08 AD+B	50	8	63	28
213-11335	TC50H63WE10 AD+B	50	10	63	35
213-11336	TC50H63WE12 AD+B	50	12	63	42
213-11337	TC50H63WE14 AD+B	50	14	63	44
213-11338	TC50H63WE16 AD+B	50	16	63	48
213-11339	TC50H63WE18 AD+B	50	18	63	50
213-11340	TC50H63WE20 AD+B	50	20	63	52
213-11341	TC50H80WE25 AD+B	50	25	80	65
213-11342	TC50H100WE32 AD+B	50	32	100	72
213-11343	TC50H120WE40 AD+B	50	40	120	80
263-11343	TC50H120WE50 AD+B	50	50	120	100

Ersatzteile / Spare parts / Pieces detachees / Componenti

Tape	Screw	Quantity
		
ISO 40	811-103009	2
ISO 50	811-103009	2

D	Locking screw	Quantity
		
6	811-106001	1
8	811-106002	1
10	811-106004	1
12,14	811-106005	1
16,18	811-106006	1
20	811-106007	1
25	811-106008	2
32	811-106009	2
40	811-106009	2
50	811-106011	2

* Ausführung Form AD
 * Execution form AD
 * Forme AD
 * Forma AD

ZYLINDERSCHAFTAUFNAHME WELDON-LANG
 END MILL HOLDERS WELDON-LONG PROJECTION TYPE
 MANDRINS POUR OUTIL TYPE WELDON-SERIE LONGUE
 MANDRINI PORTAFRESE TIPO WELDON-SERIE LUNGA

DIN 1835 B

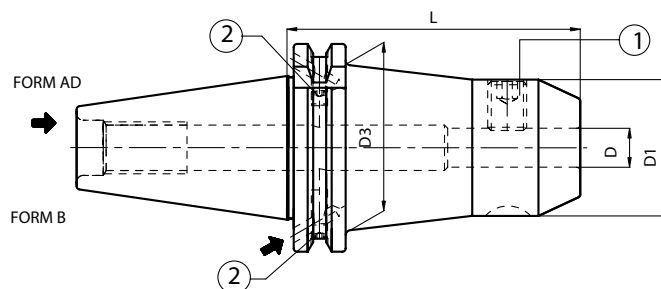

Code N.	Description	ISO	D	L	D1	D3		
H100	213-11344	TC40H100WE06 AD+B	40	6	100	25	35	
	213-11345	TC40H100WE08 AD+B	40	8	100	28	38	
	213-11346	TC40H100WE10 AD+B	40	10	100	35	40	
	213-11347	TC40H100WE12 AD+B	40	12	100	42	-	
	213-11348	TC40H100WE14 AD+B	40	14	100	44	-	
	213-11349	TC40H100WE16 AD+B	40	16	100	48	-	
	213-11370	TC40H100WE18 AD+B	40	18	100	50	-	
	213-11350	TC40H100WE20 AD+B	40	20	100	50	-	
	213-11351	TC50H100WE06 AD+B	50	6	100	25	35	
	213-11352	TC50H100WE08 AD+B	50	8	100	28	38	
	213-11353	TC50H100WE10 AD+B	50	10	100	35	42	
	213-11354	TC50H100WE12 AD+B	50	12	100	42	48	
	213-11355	TC50H100WE14 AD+B	50	14	100	44	50	
	213-11356	TC50H100WE16 AD+B	50	16	100	48	54	
	213-11357	TC50H100WE18 AD+B	50	18	100	50	56	
	213-11358	TC50H100WE20 AD+B	50	20	100	52	59	
	213-11359	TC50H100WE25 AD+B	50	25	100	65	-	
	H160	213-11362	TC40H160WE06 AD+B	40	6	160	25	35
		213-11363	TC40H160WE08 AD+B	40	8	160	28	38
213-11371		TC40H160WE10 AD+B	40	10	160	35	40	
213-11372		TC40H160WE12 AD+B	40	12	160	42	-	
213-11394		TC40H160WE14 AD+B	40	14	160	44	-	
213-11360		TC40H160WE16 AD+B	40	16	160	48	-	
213-11395		TC40H160WE18 AD+B	40	18	160	50	-	
213-11361		TC40H160WE20 AD+B	40	20	160	50	-	
213-11396		TC40H160WE25 AD+B	40	25	160	65	-	
213-11397		TC40H160WE32 AD+B	40	32	160	72	-	
213-11364		TC50H160WE06 AD+B	50	6	160	25	35	
213-11365		TC50H160WE08 AD+B	50	8	160	28	38	
213-11366		TC50H160WE10 AD+B	50	10	160	35	42	
213-11367		TC50H160WE12 AD+B	50	12	160	42	48	
213-11398		TC50H160WE14 AD+B	50	14	160	44	50	
213-11368		TC50H160WE16 AD+B	50	16	160	48	54	
213-11399		TC50H160WE18 AD+B	50	18	160	50	56	
213-11369		TC50H160WE20 AD+B	50	20	160	52	59	
263-11301		TC50H160WE25 AD+B	50	25	160	65	70	
263-11302		TC50H160WE32 AD+B	50	32	160	72	-	

ZYLINDERSCHAFTAUFNAHME WELDON-LANG
 END MILL HOLDERS WELDON-LONG PROJECTION TYPE
 MANDRINS POUR OUTIL TYPE WELDON-SERIE LONGUE
 MANDRINI PORTAFRESE TIPO WELDON-SERIE LUNGA

DIN 1835 B

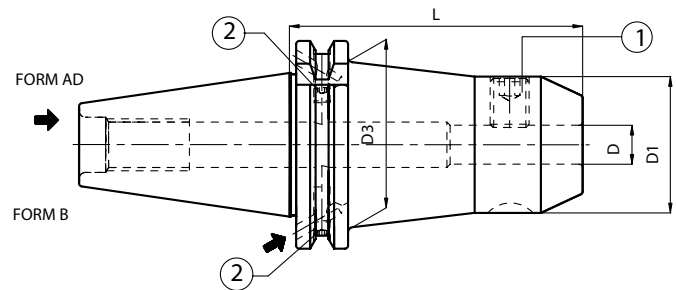

Code N.	Description	ISO	D	L	D1	D3
263-11303	TC40H200WE06 AD+B	40	6	200	25	38
263-11304	TC40H200WE08 AD+B	40	8	200	28	41
263-11305	TC40H200WE10 AD+B	40	10	200	35	43
263-11306	TC40H200WE12 AD+B	40	12	200	42	48
263-11307	TC40H200WE14 AD+B	40	14	200	44	48
263-11308	TC40H200WE16 AD+B	40	16	200	48	-
263-11309	TC40H200WE18 AD+B	40	18	200	50	-
263-11310	TC40H200WE20 AD+B	40	20	200	50	-
263-11311	TC40H200WE25 AD+B	40	25	200	65	-
263-11312	TC40H200WE32 AD+B	40	32	200	72	-
263-11313	TC50H200WE06 AD+B	50	6	200	25	38
263-11314	TC50H200WE08 AD+B	50	8	200	28	41
263-11315	TC50H200WE10 AD+B	50	10	200	35	45
263-11316	TC50H200WE12 AD+B	50	12	200	42	51
263-11317	TC50H200WE14 AD+B	50	14	200	44	53
263-11318	TC50H200WE16 AD+B	50	16	200	48	57
263-11319	TC50H200WE18 AD+B	50	18	200	50	59
263-11320	TC50H200WE20 AD+B	50	20	200	52	61
263-11321	TC50H200WE25 AD+B	50	25	200	65	72
263-11381	TC50H200WE32 AD+B	50	32	200	72	-

Ersatzteile / Spare parts / Pieces detachees / Componenti

Tape	Screw	Quantity
		
ISO 40	811-103009	2
ISO 50	811-103009	2

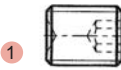
D	Locking screw	Quantity
		
6	811-106001	1
8	811-106002	1
10	811-106004	1
12,14	811-106005	1
16,18	811-106006	1
20	811-106007	1
25	811-106008	2
32	811-106009	2

KURZE ZYLINDERSCHAFTAUFNAHME WELDON
SHORT END MILL WELDON HOLDERS
MANDRINS COURTS PORTE-FRAISE TYPE WELDON
MANDRINI CORTI PORTAFRESE TIPO WELDON

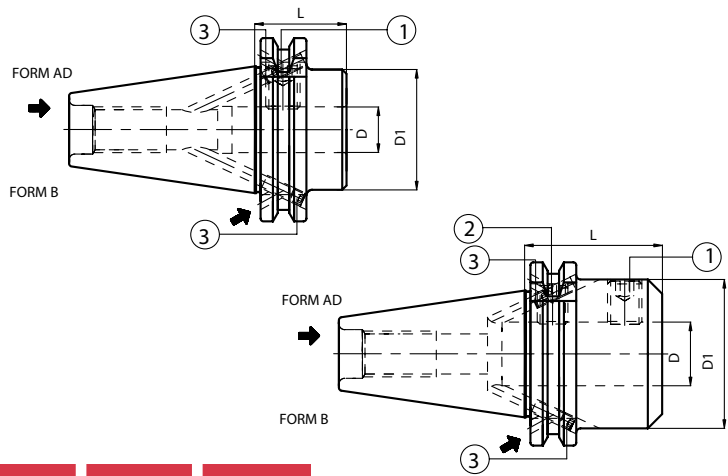

ISO 1835 B

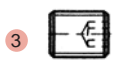

Code N.	Description	ISO	D	L	D1
263-11322	TC40H35WE16 AD+B	40	16	35	44
263-11323	TC40H35WE20 AD+B	40	20	35	44
263-11324	TC40H35WE25 AD+B	40	25	35	44
263-11325	TC40H60WE25 AD+B	40	25	60	49
263-11326	TC40H70WE32 AD+B	40	32	70	72
263-11327	TC50H35WE16 AD+B	50	16	35	70
263-11328	TC50H35WE20 AD+B	50	20	35	70
263-11329	TC50H35WE25 AD+B	50	25	35	70
263-11330	TC50H35WE32 AD+B	50	32	35	80

Ersatzteile / Spare parts / Pieces detachees / Componenti

Tape	Screw	Quantity
		
ISO 40	811-103009	2
ISO 50	811-103009	2

D	Locking screw	Quantity	Locking screw	Quantity
				
263-11322	811-106006	1	-	
263-11323	811-106007	1	-	
263-11324	811-106029	1	-	
263-11325	811-106029	2	-	
263-11326	811-106009	1	811-106026	1
263-11327	811-106006	1	-	
263-11328	811-106007	1	-	
263-11329	811-106008	1	-	
263-11330	811-106009	1	-	

ZYLINDERSCHAFTAUFNAHME WELDON MIT SPRITZDÜSE
 END MILL HOLDERS WELDON WITH COOLANT NOOSE FRONT FACE
 MANDRINS POUR OUTIL TYPE WELDON AVEC BUSE D'ARROSAGE
 MANDRINI PORTAFRESE TIPO WELDON CON SFERE DI LUBRIFICAZIONE

DIN 1835 B

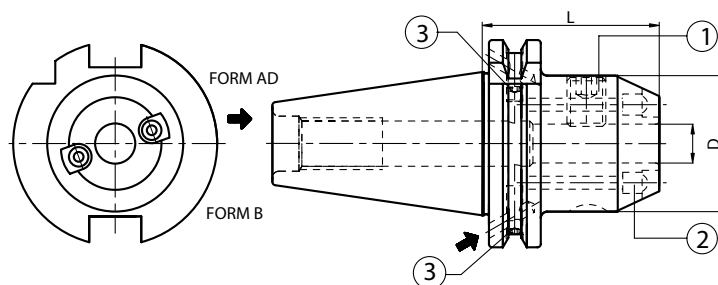

Code N.	Description	ISO	D	L	D1
213-11383	TC40H50WE06-CNFF AD+B	40	6	50	25
213-11384	TC40H50WE08-CNFF AD+B	40	8	50	28
213-11385	TC40H50WE10-CNFF AD+B	40	10	50	35
213-11386	TC40H50WE12-CNFF AD+B	40	12	50	42
213-11387	TC40H50WE14-CNFF AD+B	40	14	50	44
213-11388	TC40H63WE16-CNFF AD+B	40	16	63	48
213-11389	TC40H63WE18-CNFF AD+B	40	18	63	50
213-11390	TC40H63WE20-CNFF AD+B	40	20	63	52
213-11391	TC40H100WE25-CNFF AD+B	40	25	100	65
213-11392	TC40H100WE32-CNFF AD+B	40	32	100	72
263-11331	TC40H115WE40-CNFF AD+B	40	40	115	80
263-11332	TC50H63WE06-CNFF AD+B	50	6	63	25
263-11333	TC50H63WE08-CNFF AD+B	50	8	63	28
263-11334	TC50H63WE10-CNFF AD+B	50	10	63	35
263-11335	TC50H63WE12-CNFF AD+B	50	12	63	42
263-11336	TC50H63WE14-CNFF AD+B	50	14	63	44
263-11337	TC50H63WE16-CNFF AD+B	50	16	63	48
263-11338	TC50H63WE18-CNFF AD+B	50	18	63	50
263-11339	TC50H63WE20-CNFF AD+B	50	20	63	52
263-11340	TC50H80WE25-CNFF AD+B	50	25	80	65
263-11341	TC50H100WE32-CNFF AD+B	50	32	100	72
263-11342	TC50H120WE40-CNFF AD+B	50	40	120	80

Ersatzteile / Spare parts / Pieces detachees / Componenti

Tape	Screw	Quantity
ISO 40	811-103009	2
ISO 50	811-103009	2

D	Locking screw	Quantity	Coolant noose
6	811-106001	1	PWZ1005D6x4.5
8	811-106002	1	PWZ1005D6x4.5
10	811-106004	1	PWZ1005D6x4.5
12,14	811-106005	1	PWZ1005D6x4.5
16,18	811-106006	1	PWZ1008D10x7
20	811-106007	1	PWZ1008D10x7
25	811-106008	2	PWZ1012D12x8
32	811-106009	2	PWZ1012D12x8
40	811-106009	2	PWZ1012D12x8

ZYLINDERSCHAFTAUFNAHME WHISTLE NOTCH
 END MILL HOLDERS WHISTLE NOTCH
 MANDRINS POUR OUTIL TYPE WHISTLE NOTCH
 MANDRINI PORTAFRESE TIPO WHISTLE NOTCH

DIN 1835 E

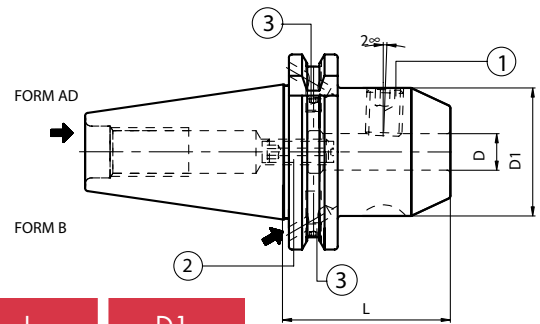

Code N.	Description	ISO	D	L	D1
213-31317	TC40H50WN06 AD+B	40	6	50	25
213-31318	TC40H50WN08 AD+B	40	8	50	28
213-31319	TC40H50WN10 AD+B	40	10	50	35
213-31320	TC40H50WN12 AD+B	40	12	50	42
213-31321	TC40H50WN14 AD+B	40	14	50	44
213-31322	TC40H63WN16 AD+B	40	16	63	48
213-31323	TC40H63WN18 AD+B	40	18	63	50
213-31324	TC40H63WN20 AD+B	40	20	63	52
213-31325	TC40H100WN25 AD+B	40	25	100	65
213-31326	TC40H100WN32 AD+B	40	32	100	72
213-31327	TC40H115WN40 AD+B	40	40	115	80
213-31328	TC50H63WN06 AD+B	50	6	63	25
213-31329	TC50H63WN08 AD+B	50	8	63	28
213-31330	TC50H63WN10 AD+B	50	10	63	35
213-31331	TC50H63WN12 AD+B	50	12	63	42
213-31332	TC50H63WN14 AD+B	50	14	63	44
213-31333	TC50H63WN16 AD+B	50	16	63	48
213-31334	TC50H63WN18 AD+B	50	18	63	50
213-31335	TC50H63WN20 AD+B	50	20	63	52
213-31336	TC50H80WN25 AD+B	50	25	80	65
213-31337	TC50H100WN32 AD+B	50	32	100	72
213-31338	TC50H120WN40 AD+B	50	40	120	80

Ersatzteile / Spare parts / Pieces detachees / Componenti

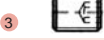
Tape	Screw	Quantity
		
ISO 40	811-103009	2
ISO 50	811-103009	2

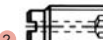
D	Locking screw	Quantity	Stop screw	Quantity
				
6	811-106001	1	811-303043	1
8	811-106002	1	811-303081	1
10	811-106004	1	811-303082	1
12,14	811-106005	1	811-303083	1
16,18	811-106006	1	811-303084	1
20	811-106007	1	811-303084	1
ISO 40/25	811-106008	2	811-303098	1
ISO 50/25	811-106008	2	811-303085	1
ISO 40/32	811-106009	2	811-303098	1
ISO 50/32	811-106009	2	811-303085	1
ISO 40/40	811-106009	2	811-303098	1
ISO 50/40	811-106009	2	811-303085	1

ZYLINDERSCHAFTAUFNAHME WHISTLE NOTCH -LANG
 END MILL HOLDERS WHISTLE NOTCH -LONG PROJECTION TYPE
 MANDRINS POUR OUTIL TYPE WHISTLE NOTCH -SERIE LONGUE
 MANDRINI PORTAFRESE TIPO WHISTLE NOTCH -SERIE LUNGA

DIN 1835 E

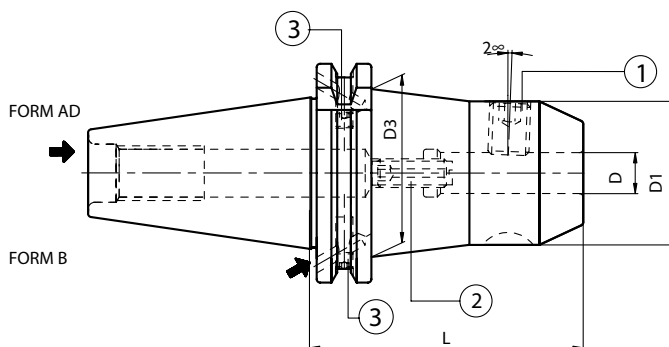

Code N.	Description	ISO	D	L	D1	D3		
H100	213-31308	TC40H100WN06 AD+B	40	6	100	25	35	
	213-31309	TC40H100WN08 AD+B	40	8	100	28	38	
	213-31310	TC40H100WN10 AD+B	40	10	100	35	40	
	213-31311	TC40H100WN12 AD+B	40	12	100	42	-	
	213-31312	TC40H100WN14 AD+B	40	14	100	44	-	
	213-31313	TC40H100WN16 AD+B	40	16	100	48	-	
	213-31339	TC40H100WN18 AD+B	40	18	100	50	-	
	213-31340	TC40H100WN20 AD+B	40	20	100	50	-	
	213-31341	TC50H100WN06 AD+B	50	6	100	25	35	
	213-31342	TC50H100WN08 AD+B	50	8	100	28	38	
	213-31343	TC50H100WN10 AD+B	50	10	100	35	42	
	213-31344	TC50H100WN12 AD+B	50	12	100	42	48	
	213-31345	TC50H100WN14 AD+B	50	14	100	44	50	
	213-31346	TC50H100WN16 AD+B	50	16	100	48	54	
	213-31347	TC50H100WN18 AD+B	50	18	100	50	56	
	213-31348	TC50H100WN20 AD+B	50	20	100	52	59	
	213-31349	TC50H100WN25 AD+B	50	25	100	65	-	
	H160	213-31350	TC40H160WN06 AD+B	40	6	160	25	35
		213-31351	TC40H160WN08 AD+B	40	8	160	28	38
213-31352		TC40H160WN10 AD+B	40	10	160	35	40	
213-31353		TC40H160WN12 AD+B	40	12	160	42	-	
213-31354		TC40H160WN14 AD+B	40	14	160	44	-	
213-31355		TC40H160WN16 AD+B	40	16	160	48	-	
213-31356		TC40H160WN18 AD+B	40	18	160	50	-	
213-31357		TC40H160WN20 AD+B	40	20	160	50	-	
213-31358		TC40H160WN25 AD+B	40	25	160	65	-	
213-31359		TC40H160WN32 AD+B	40	32	160	72	-	
213-31360		TC50H160WN06 AD+B	50	6	160	25	35	
213-31361		TC50H160WN08 AD+B	50	8	160	28	38	
213-31362		TC50H160WN10 AD+B	50	10	160	35	42	
213-31363		TC50H160WN12 AD+B	50	12	160	42	48	
213-31364		TC50H160WN14 AD+B	50	14	160	44	50	
213-31365		TC50H160WN16 AD+B	50	16	160	48	54	
213-31366		TC50H160WN18 AD+B	50	18	160	50	56	
213-31367		TC50H160WN20 AD+B	50	20	160	52	59	
263-31368		TC50H160WN25 AD+B	50	25	160	65	70	
263-31369		TC50H160WN32 AD+B	50	32	160	72	-	

ZYLINDERSCHAFTAUFNAHME WHISTLE NOTCH -LANG
 END MILL HOLDERS WHISTLE NOTCH -LONG PROJECTION TYPE
 MANDRINS POUR OUTIL TYPE WHISTLE NOTCH -SERIE LONGUE
 MANDRINI PORTAFRESE TIPO WHISTLE NOTCH -SERIE LUNGA

DIN 1835 E

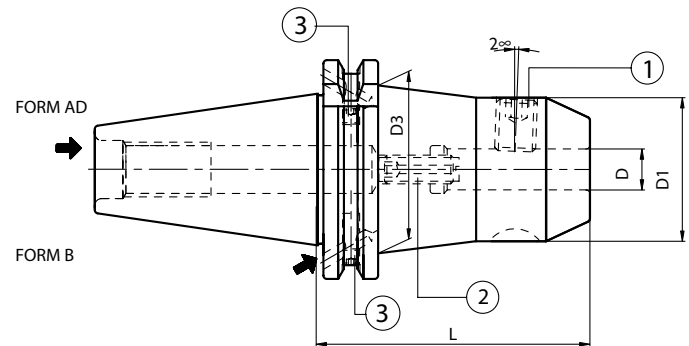

Code N.	Description	ISO	D	L	D1	D3
263-31370	TC40H200WN06 AD+B	40	6	200	25	38
263-31371	TC40H200WN08 AD+B	40	8	200	28	41
263-31372	TC40H200WN10 AD+B	40	10	200	35	43
263-31373	TC40H200WN12 AD+B	40	12	200	42	48
263-31374	TC40H200WN14 AD+B	40	14	200	44	48
263-31375	TC40H200WN16 AD+B	40	16	200	48	-
263-31376	TC40H200WN18 AD+B	40	18	200	50	-
263-31377	TC40H200WN20 AD+B	40	20	200	50	-
263-31378	TC40H200WN25 AD+B	40	25	200	65	-
263-31379	TC40H200WN32 AD+B	40	32	200	72	-
263-31380	TC50H200WN06 AD+B	50	6	200	25	38
263-31381	TC50H200WN08 AD+B	50	8	200	28	41
263-31382	TC50H200WN10 AD+B	50	10	200	35	45
263-31383	TC50H200WN12 AD+B	50	12	200	42	51
263-31384	TC50H200WN14 AD+B	50	14	200	44	53
263-31385	TC50H200WN16 AD+B	50	16	200	48	57
263-31386	TC50H200WN18 AD+B	50	18	200	50	59
263-31387	TC50H200WN20 AD+B	50	20	200	52	61
263-31388	TC50H200WN25 AD+B	50	25	200	65	72
213-31389	TC50H200WN32 AD+B	50	32	200	72	-

Ersatzteile / Spare parts / Pieces detachees / Componenti

Tape	Screw	Quantity
ISO 40	811-103009	2
ISO 50	811-103009	2

D	Locking screw	Quantity	Stop screw	Quantity
6	811-106001	1	811-303043	1
8	811-106002	1	811-303081	1
10	811-106004	1	811-303082	1
12,14	811-106005	1	811-303083	1
16,18	811-106006	1	811-303084	1
20	811-106007	1	811-303084	1
25	811-106008	2	811-303085	1
32	811-106009	2	811-303085	1

**KOMBI AUFSTECKFRÄSDORNE
COMBI-SHELL MILL ADAPTORS
MANDRINS PORTE-FRAISES A DOUBLE USAGE
MANDRINI PORTAFRESE COMBINATI**

DIN 6358

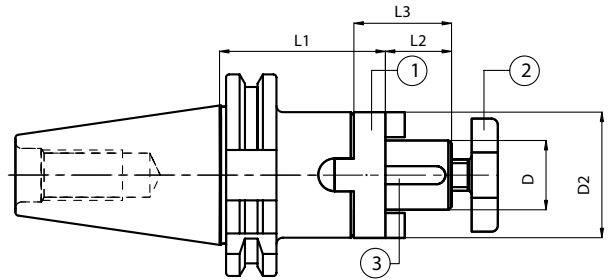

Code N.	Description	ISO	D	L1	L2	L3	D2	
STANDARD	216-11232	TC30H50D16C	30	16	50	17	27	32
	216-11234	TC30H50D22C	30	22	50	19	31	40
	216-11236	TC30H55D27C	30	27	55	21	33	48
	216-11201	TC40H55D16C	40	16	55	17	27	32
	216-11202	TC40H55D22C	40	22	55	19	31	40
	216-11203	TC40H55D27C	40	27	55	21	33	48
	216-11204	TC40H60D32C	40	32	60	24	38	58
	216-11205	TC40H60D40C	40	40	60	27	41	70
	216-11206	TC50H55D16C	50	16	55	17	27	32
	216-11207	TC50H55D22C	50	22	55	19	31	40
	216-11208	TC50H55D27C	50	27	55	21	33	48
216-11209	TC50H55D32C	50	32	55	24	38	58	
216-11210	TC50H55D40C	50	40	55	27	41	70	
216-11211	TC50H70D50C	50	50	70	30	46	90	

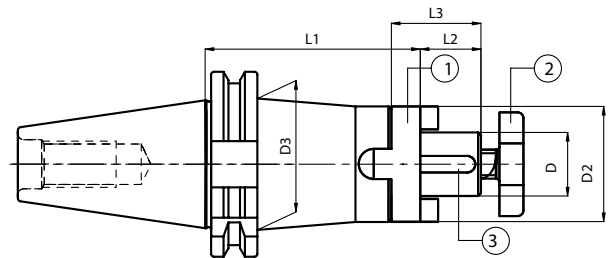

Code N.	Description	ISO	D	L1	L2	L3	D2	D3	
EXTENDED	216-11213	TC40H90D16C	40	16	90	17	27	32	44
	216-11214	TC40H90D22C	40	22	90	19	31	40	-
	216-11215	TC40H90D27C	40	27	90	21	33	48	-
	216-11216	TC40H100D32C	40	32	100	24	38	58	-
	216-11217	TC40H100D40C	40	40	100	27	41	70	-
	216-11218	TC50H100D16C	50	16	100	17	27	32	50
	216-11219	TC50H100D22C	50	22	100	19	31	40	60
	216-11220	TC50H100D27C	50	27	100	21	33	48	60
	216-11221	TC50H100D32C	50	32	100	24	38	58	-
	216-11222	TC50H100D40C	50	40	100	27	41	70	-

Ersatzteile / Spare parts / Pieces detachees / Componenti

D	Ring	Screw	Key
16	814-30001	811-107003	814-201010
22	814-30002	811-107004	814-201020
27	814-30003	811-107005	814-201030
32	814-30004	811-107006	814-201040
40	814-30005	811-107007	814-201050
50	814-30006	811-107009	814-201060

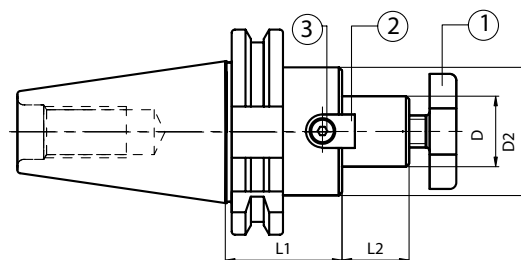

**AUFSTECKFRÄSDORNE FÜR FRÄSER MIT QUERNUT
FACE MILL HOLDERS-TENONS DRIVE
MANDRINS PORTE-FRAISE-ENTRAÎNEMENT PAR TENONS
MANDRINI PORTAFRESE A TRASCINAMENTO FISSO**

ISO 3937



Code N.	Description	ISO	D	L1	L2	D2
216-71201	TC30H35D16F	30	16	35	17	38
216-71202	TC30H35D22F	30	22	35	19	48
216-71203	TC30H50D27F	30	27	50	21	58
216-71204	TC40H45D16F	40	16	45	17	38
216-71205	TC40H45D22F	40	22	45	19	48
216-71206	TC40H50D27F	40	27	50	21	58
216-71207	TC40H55D32F	40	32	55	24	78
216-71208	TC40H55D40F	40	40	55	27	88
216-71214	TC50H45D16F	50	16	45	17	38
216-71215	TC50H45D22F	50	22	45	19	48
216-71216	TC50H45D27F	50	27	45	21	58
216-71217	TC50H50D32F	50	32	50	24	78
216-71218	TC50H55D40F	50	40	55	27	88

Ersatzteile / Spare parts / Pieces detachees / Componenti

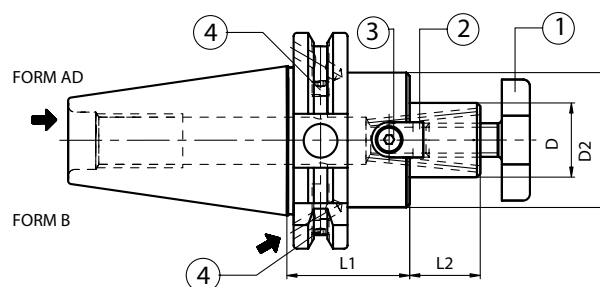

D	Screw	Tenon	Screw
			
16	811-107003	814-20228	811-101004
22	811-107004	814-20225	811-101011
27	811-107005	814-20227	811-101018
32	811-107006	814-20263	811-101029
40	811-107007	814-20271	811-101029

AUFSTECKFRÄSDORNE FÜR FRÄSER MIT QUERNUT MIT KÜHLMITTELZUFUHR
FACE MILL HOLDERS-TENONS DRIVE-WITH INTERNAL COOLANT SUPPLY
MANDRINS PORTE-FRAISE-ENTRAÎNEMENT PAR TENONS AVEC ARROSSAGE INTERNE
MANDRINI PORTAFRESE A TRASCINAMENTO FISSO CON PASSAGGIO REFRIGERANTE **ISO 3937**

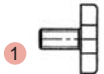

Code N.	Description	ISO	D	L1	L2	D2
216-71301	TC40H45D16F AD+B	40	16	45	17	38
216-71302	TC40H45D22F AD+B	40	22	45	19	48
216-71303	TC40H50D27F AD+B	40	27	50	21	58
216-71304	TC40H55D32F AD+B	40	32	55	24	78
216-71305	TC40H55D40F AD+B	40	40	55	27	88
216-71306	TC50H45D16F AD+B	50	16	45	17	38
216-71307	TC50H45D22F AD+B	50	22	45	19	48
216-71308	TC50H45D27F AD+B	50	27	45	21	58
216-71309	TC50H55D32F AD+B	50	32	55	24	78
216-71310	TC50H55D40F AD+B	50	40	55	27	88

Ersatzteile / Spare parts / Pieces detachees / Componenti

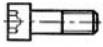
Tape	Screw	Quantity	D	Screw	Tenon	Screw
						
ISO 40	811-103009	2	16	811-107003	814-20228	811-101004
ISO 50	811-103009	2	22	811-107004	814-20225	811-101011
			27	811-107005	814-20227	811-101018
			32	811-107006	814-20263	811-101029
			40	811-107007	814-20271	811-101029

**AUFSTECKFRÄSDORNE FÜR FRÄSER MIT QUERNUT-LANG
FACE MILL HOLDERS-TENONS DRIVE-LONG PROJECTION TYPE
MANDRINS PORTE-FRAISE-ENTRAÎNEMENT PAR TENONS-SERIE LONGUE
MANDRINI PORTAFRESE A TRASCINAMENTO FISSO-SERIE LUNGA**

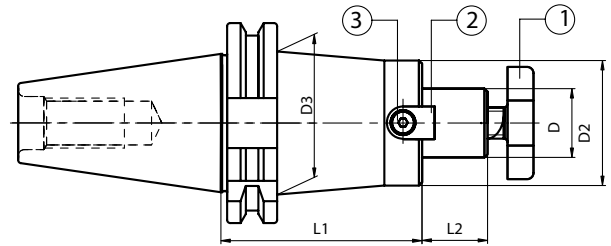

ISO 3937



	Code N.	Description	ISO	D	L1	L2	D2	D3	
H 100	216-71255	TC40H100D16F	40	16	100	17	39	-	
	216-71259	TC40H100D22F	40	22	100	19	46	48	A
	266-71233	TC50H100D16F	50	16	100	17	38	-	
	216-71267	TC50H100D22F	50	22	100	19	46	48	A
	216-71272	TC50H100D22F	50	22	100	19	50	60	B
	216-71277	TC50H100D27F	50	27	100	21	55	78	C
	266-71256	TC50H100D32F	50	32	100	24	66	78	
H 150	216-71256	TC40H150D16F	40	16	150	17	39	-	
	216-71260	TC40H150D22F	40	22	150	19	46	48	A
	266-71234	TC50H150D16F	50	16	150	17	38	-	
	216-71268	TC50H150D22F	50	22	150	19	46	48	A
	216-71273	TC50H150D22F	50	22	150	19	50	60	B
	216-71278	TC50H150D27F	50	27	150	21	55	78	C
	266-71257	TC50H150D32F	50	32	150	24	66	78	
H 200	216-71257	TC40H200D16F	40	16	200	17	39	-	
	216-71261	TC40H200D22F	40	22	200	19	46	48	A
	266-71250	TC50H200D16F	50	16	200	17	39	-	
	216-71269	TC50H200D22F	50	22	200	19	46	48	A
	216-71274	TC50H200D22F	50	22	200	19	50	60	B
	216-71279	TC50H200D27F	50	27	200	21	55	78	C
	266-71258	TC50H200D32F	50	32	200	24	66	78	

A/Für Fräser D50/Suitable for milling cutters D50/ Adaptes pour fraises D50/ Adatti per frese D50
 B/Für Fräser D63/Suitable for milling cutters D63/ Adaptes pour fraises D63/ Adatti per frese D63
 C/Für Fräser D80/Suitable for milling cutters D80/ Adaptes pour fraises D80/ Adatti per frese D80

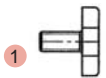
Ersatzteile / Spare parts / Pieces detachees / Componenti

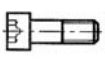

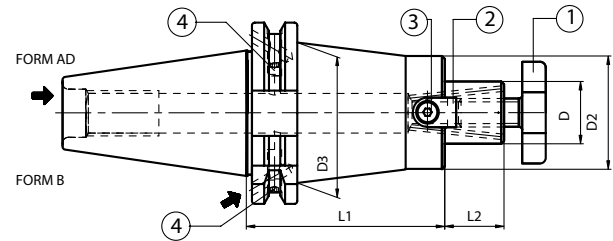

D	Screw	Tenon	Screw
			
16	811-107003	814-20228	811-101004
22/46	811-107004	814-20225	811-101011
22/50	811-107004	814-20226	811-101012
27	811-107005	814-20227	811-101017
32	811-107006	814-20229	811-101029

AUFSTECKFRÄSDORNE FÜR FRÄSER MIT QUERNUT MIT KÜHLMITTELZUFUHR-LANG
FACE MILL HOLDERS-TENONS DRIVE-WITH INTERNAL COOLANT SUPPLY-LONG
MANDRINS PORTE-FRAISE-ENTRAÎNEMENT PAR TENONS AVEC ARROSSAGE INTERNE-LONGUE
MANDRINI PORTAFRESE A TRASCINAMENTO FISSO CON PASSAGGIO REFRIGERANTE-LUNGA **ISO 3937**



Code N.	Description	ISO	D	L1	L2	D2	D3
216-71321	TC40H100D16F AD+B	40	16	100	17	32	42
216-71322	TC40H100D22F AD+B	40	22	100	19	40	49
216-71323	TC40H100D27F AD+B	40	27	100	21	48	-
216-71324	TC40H100D32F AD+B	40	32	100	24	58	-
216-71312	TC50H100D16F AD+B	50	16	100	17	32	42
216-71313	TC50H100D22F AD+B	50	22	100	19	40	55
216-71314	TC50H100D27F AD+B	50	27	100	21	48	60
216-71315	TC50H100D32F AD+B	50	32	100	24	58	68
216-71316	TC50H100D40F AD+B	50	40	100	27	70	-

Ersatzteile / Spare parts / Pieces detachees / Componenti

Tape	Screw	Quantity	D	Screw	Tenon	Screw
						
ISO 40	811-103009	2	16	811-107003	814-20214	811-101003
ISO 50	811-103009	2	22	811-107004	814-20215	811-101010
			27	811-107005	814-20216	811-101017
			32	811-107006	814-20217	811-101027
			40	811-107007	814-20218	811-101028

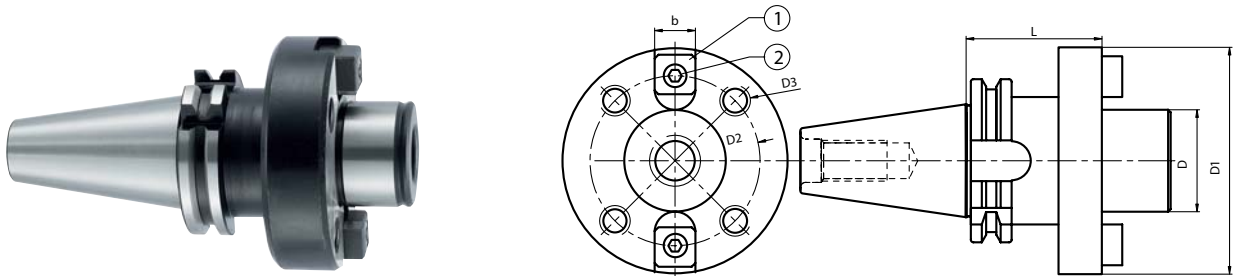

AUFSTECKFRÄSERDORNE FÜR MESSERKÖPFE
FACE MILL HOLDER FOR FACE MILLING CUTTERS
MANDRINS PORTE-FRAISE POUR FRAISES A SURFACER
MANDRINI PORTAFRESE PER FRESE A SPIANARE

DIN 6357



Code N.	Description	ISO	D	L	D1	D2	D3	b
216-21201	TC40H60D40	40	40	60	89	66.7	M12	15.9
216-21202	TC50H70D40	50	40	70	89	66.7	M12	15.9
216-21203	TC50H70D60	50	60	70	129	101.6	M16	25.4

Ersatzteile / Spare parts / Pieces detachees / Componenti

D	Tenon	Screw
		
40	814-202080	811-101028
60	814-202120	811-101063

ZWISCHENHÜSEN FÜR MORSEKEGEL MIT AUSTREIBBLAPPEN
MORSE TAPER ADAPTORS FOR DRILLS
DOUILLES POUR CONE MORSE A TENON
MANDRINI PORTAPUNTE ATTACCO CONO MORSE

DIN 228-2 FORM D

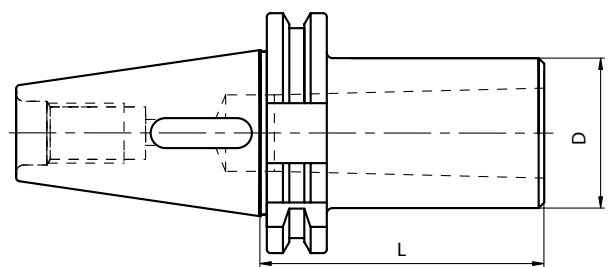

Code N.	Description	ISO	MORSE	D	L
212-41214	TC30H55CM1P	30	1	25	55
212-41215	TC30H60CM2P	30	2	32	60
212-41216	TC30H90CM3P	30	3	40	90
212-41201	TC40H50CM1P	40	1	25	50
212-41202	TC40H50CM2P	40	2	32	50
212-41203	TC40H70CM3P	40	3	40	70
212-41204	TC40H95CM4P	40	4	48	95
212-41205	TC50H50CM1P	50	1	25	50
212-41206	TC50H60CM2P	50	2	32	60
212-41207	TC50H65CM3P	50	3	40	65
212-41208	TC50H95CM4P	50	4	48	95
212-41209	TC50H120CM5P	50	5	63	120

ZWISCHENHÜLSEN FÜR MORSEKEGEL MIT ANZUGSGEWINDE
MORSE TAPER ADAPTER WITH TREAD
DOUILLES POUR CONE MORSE AVEC TARAUDAGE
MANDRINI PORTAFRESE ATTACCO CONO MORSE

DIN 228-2 FORM C

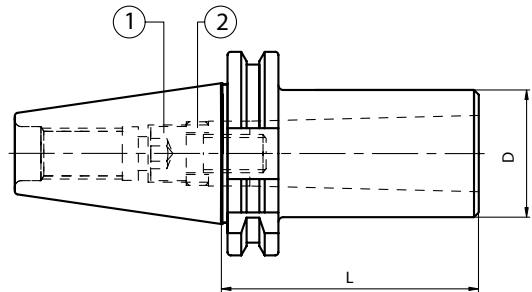

Code N.	Description	ISO	MORSE	D	L
212-21214	TC30H50CM1F	30	1	25	50
212-21215	TC30H60CM2F	30	2	32	60
212-21216	TC30H80CM3F	30	3	40	80
212-21201	TC40H50CM1F	40	1	25	50
212-21202	TC40H50CM2F	40	2	32	50
212-21203	TC40H70CM3F	40	3	40	70
212-21204	TC40H95CM4F	40	4	48	95
212-21205	TC50H45CM1F	50	1	25	45
212-21206	TC50H60CM2F	50	2	32	60
212-21207	TC50H65CM3F	50	3	40	65
212-21208	TC50H95CM4F	50	4	48	95
212-21209	TC50H120CM5F	50	5	63	120

Ersatzteile / Spare parts / Pieces detachees / Componenti

TC/MORSE	Screw (TCA)	Screw (TCAD/B)	Ring
30/1	811-111009	-	811-302037
30/2	811-111007	-	811-302031
30/3	811-111008	-	811-302032
40/1	811-101029	-	811-302030
40/2	811-111007	811-111038	811-302031
40/3	811-111008	811-401098	811-302032
40/4	811-111005	811-401083	811-302036
50/1	811-101029	-	811-302030
50/2	811-101054	811-401084	811-302032
50/3	811-101065	811-401085	811-302032
50/4	811-401037	811-401086	811-302036
50/5	811-101092	811-401087	811-302034



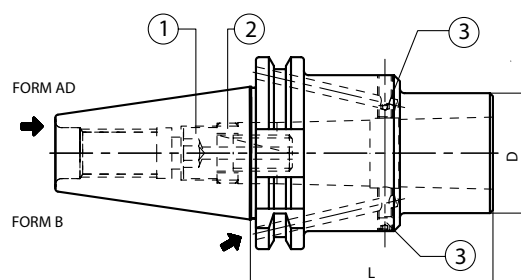

ZWISCHENHÜLSEN FÜR MORSEKEGEL MIT ANZUGSGEWINDE
MORSE TAPER ADAPTER WITH TREAD
DOUILLES POUR CONE MORSE AVEC TARAUDAGE
MANDRINI PORTAFRESE ATTACCO CONO MORSE

DIN 228-2 FORM C

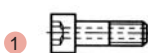

Code N.	Description	ISO	MORSE	D	L
212-31321	TC40H50CM2F AD+B	40	2	32	50
212-31322	TC40H70CM3F AD+B	40	3	40	70
212-31323	TC40H95CM4F AD+B	40	4	48	95
212-31324	TC50H60CM2F AD+B	50	2	32	60
212-31325	TC50H65CM3F AD+B	50	3	40	65
212-31326	TC50H95CM4F AD+B	50	4	48	95
212-31327	TC50H120CM5F AD+B	50	5	63	120

Ersatzteile / Spare parts / Pieces detachees / Componenti

Tape/MORSE	Screw	Quantity	TC/MORSE	Screw (TCA)	Screw (TCAD/B)	Ring
						
40/2	811-102010	2	30/1	811-111009	-	811-302037
40/3;4	811-103010	2	30/2	811-111007	-	811-302031
50	811-102018	2	30/3	811-111008	-	811-302032
			40/1	811-101029	-	811-302030
			40/2	811-111007	811-111038	811-302031
			40/3	811-111008	811-401098	811-302032
			40/4	811-111005	811-401083	811-302036
			50/1	811-101029	-	811-302030
			50/2	811-101054	811-401084	811-302032
			50/3	811-101065	811-401085	811-302032
			50/4	811-401037	811-401086	811-302036
			50/5	811-101092	811-401087	811-302034

**ZWISCHENHÜSEN FÜR MORSEKEGEL MIT AUSTREIBBLAPPEN ODER ANZUGSGEWINDE
MORSE TAPER ADAPTORS FOR DRILLS AND MILLS
DOUILLES POUR CONE MORSE A TENON ET AVEC TARAUDAGE
MANDRINI PORTAPUNTE-PORTAFRESE ATTACCO CONO MORSE **DIN 228-2 FORM C/D****

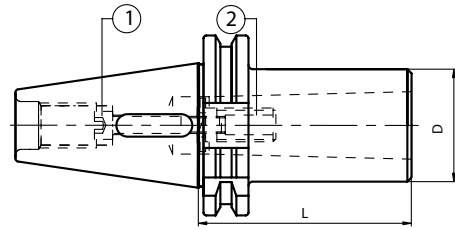

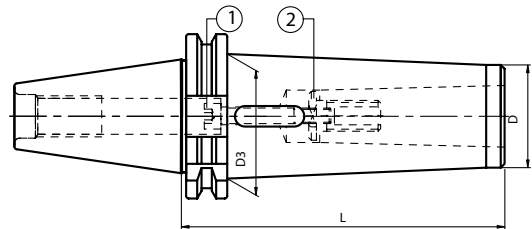

	Code N.	Description	ISO	MORSE	D	L
STANDARD	212-61219	TC30H55CM1P/F	30	1	25	55
	212-61220	TC30H65CM2P/F	30	2	32	65
	212-61221	TC30H90CM3P/F	30	3	40	90
	212-61201	TC40H50CM1P/F	40	1	25	50
	212-61202	TC40H60CM2P/F	40	2	32	60
	212-61203	TC40H75CM3P/F	40	3	40	75
	212-61205	TC50H45CM1P/F	50	1	25	45
	212-61206	TC50H60CM2P/F	50	2	30	60
	212-61207	TC50H65CM3P/F	50	3	36	65
	212-61208	TC50H95CM4P/F	50	4	48	95
212-61209	TC50H120CM5P/F	50	5	63	120	

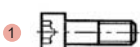

	Code N.	Description	ISO	MORSE	D	D3	L
EXTENDED	212-61222	TC30H110CM1P/F	30	1	18	25	110
	212-61223	TC30H120CM2P/F	30	2	25	32	120
	212-61224	TC30H140CM3P/F	30	3	33	40	140
	212-61210	TC40H115CM1P/F	40	1	18	25	115
	212-61211	TC40H125CM2P/F	40	2	25	32	125
	212-61212	TC40H140CM3P/F	40	3	33	40	140
	212-61214	TC50H120CM1P/F	50	1	18	25	120
	212-61215	TC50H140CM2P/F	50	2	25	32	140
	212-61216	TC50H150CM3P/F	50	3	33	40	150
	212-61217	TC50H180CM4P/F	50	4	40	48	180
212-61218	TC50H220CM5P/F	50	5	55	63	220	

Ersatzteile / Spare parts / Pièces detachees / Componenti

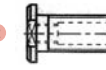
Code N.	Screw	Ring	Code N.	Screw	Ring
					
212-61219	811-101032	-	212-61222	811-101034	-
212-61220	811-101032	811-302010	212-61223	811-101035	811-302010
212-61221	811-101035	811-302006	212-61224	811-101037	811-302006
212-61201	811-101033	-	212-61210	811-101037	-
212-61202	811-401018	-	212-61211	811-101061	-
212-61203	811-101034	811-302006	212-61212	811-101081	811-302006
212-61205	811-101033	-	212-61214	811-101055	-
212-61206	811-101057	-	212-61215	811-401046	-
212-61207	811-101071	-	212-61216	811-101079	-
212-61208	811-401016	-	212-61217	811-401030	-
212-61209	811-101071	811-302008	212-61218	811-101080	811-302008

**ZWISCHENHÜLSEN SK X HSK – HAND SPANNSYSTEM
TAPER ADAPTER SA X HSK – MANUAL CLAMPING
DOUILLES INTERMEDIAIRES SA X HSK – SERRAGE MANUEL
MANDRINI RIDUZIONE DA TC A HSK – CHIUSURA MANUALE**

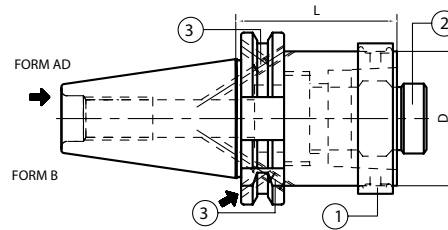

Code N.	Description	ISO	HSK	D	L	① Ring (complete)	② Locking unit (complete)
212-91305	TC40H50HSK40 AD+B	40	40	40	50	H40A-AN	H40A-UBL
212-91301	TC40H60HSK50 AD+B	40	50	50	60	H50A-AN	H50A-UBL
212-91302	TC40H80HSK63 AD+B	40	63	63	80	H63A-AN	H63A-UBL
212-91306	TC50H50HSK40 AD+B	50	40	40	50	H40A-AN	H40A-UBL
212-91303	TC50H50HSK50 AD+B	50	50	50	50	H50A-AN	H50A-UBL
212-91304	TC50H60HSK63 AD+B	50	63	63	60	H63A-AN	H63A-UBL

DIN 69871 A

**ZWISCHENHÜLSEN SK X SK
ISO TAPER ADAPTORS
DOUILLES INTERMEDIAIRES TC X SA
MANDRINI RIDUZIONE E PROLUNGE TC/ ISO**

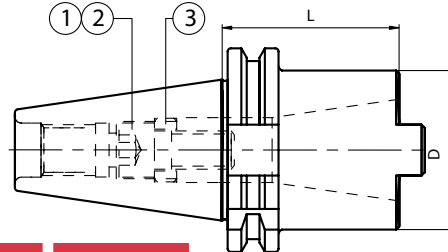

Code N.	Description	ISO	ISO	D	L
212-11204	TC40H60ISO30/TC30	40	30	49	60
212-11213	TC40H100ISO40/TC40	40	40	68	100
212-11201	TC50H70ISO40/TC40	50	40	68	70
212-11214	TC50H120ISO50/TC50	50	50	100	120

Ersatzteile / Spare parts / Pieces detachees / Componenti

TC/ISO	Screw (ISO)	Screw (TC)	Ring	Wrench
	①	②	③	
40/30	811-101065	811-101070	811-302032	816-202060
40/40	811-111005	811-111023	811-302036	816-202070
50/40	811-111005	811-111023	811-302036	816-202070
50/50	811-401052	811-401135	811-302047	816-202090

Schraubenschlüssel und Verschlußschraube für DIN69871/MAS BT/DIN2080 werden mitgeliefert
Supplied with a wrench and a screw DIN69871/MAS BT/DIN2080
Livré avec une clé et une vis de serrage DIN69871/MAS BT/DIN2080
In dotazione chiave e vite per chiusura DIN69871/MAS BT/DIN2080

SPANNZANGENFUTTER ER TYP
ER COLLET CHUCK
MANDRINS A PINCES TYPE ER
MANDRINI PORTAPINZA TIPO ER

DIN 6499

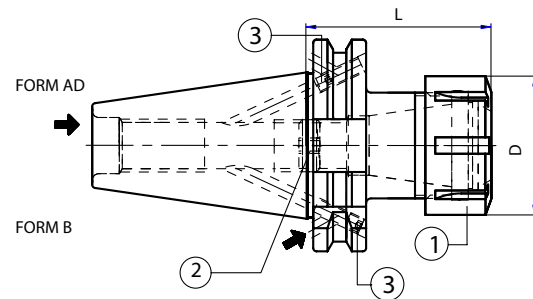

	Code N.	Description	ISO	ER	D	L
STANDARD	*214-31211	TC30H55ER16	30	16	32	55
	*214-31212	TC30H55ER25	30	25	42	55
	*214-31228	TC30H60ER32	30	32	50	60
	214-31362	TC40H70ER16 AD+B	40	16	32	70
	214-31329	TC40H70ER25 AD+B	40	25	42	70
	214-31331	TC40H70ER32 AD+B	40	32	50	70
	214-31333	TC40H70ER40 AD+B	40	40	63	70
	214-31341	TC50H70ER25 AD+B	50	25	42	70
	214-31335	TC50H70ER32 AD+B	50	32	50	70
	214-31338	TC50H80ER40 AD+B	50	40	63	80

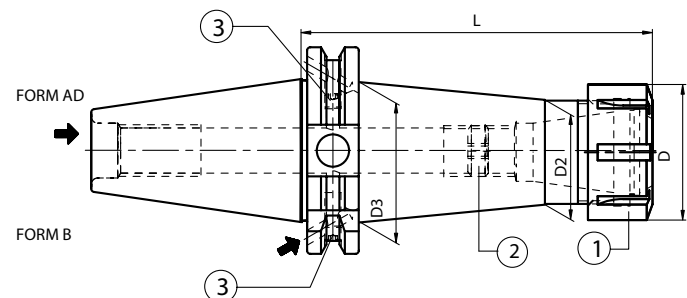

	Code N.	Description	ISO	ER	D	L	D2	D3
EXTENDED	*214-31213	TC30H100ER16	30	16	32	100	22	28
	*214-31214	TC30H100ER25	30	25	42	100	32	32
	214-31363	TC40H100ER16 AD+B	40	16	32	100	22	32
	214-31347	TC40H100ER25 AD+B	40	25	42	100	32	42
	214-31348	TC40H100ER32 AD+B	40	32	50	100	40	50
	214-31364	TC40H100ER40 AD+B	40	40	63	100	50	50
	214-31365	TC50H100ER16 AD+B	50	16	32	100	22	32
	214-31342	TC50H100ER25 AD+B	50	25	42	100	32	42
	214-31336	TC50H100ER32 AD+B	50	32	50	100	40	50
	214-31339	TC50H100ER40 AD+B	50	40	63	100	50	63

*Ausführung Form AD

*Execution form AD

*Forme AD

*Forma AD

SPANNZANGENFUTTER ER TYP - LANG
ER COLLET CHUCK - LONG
MANDRINS A PINCES TYPE ER - SERIE LONGUE
MANDRINI PORTAPINZA TIPO ER - SERIE LUNGA

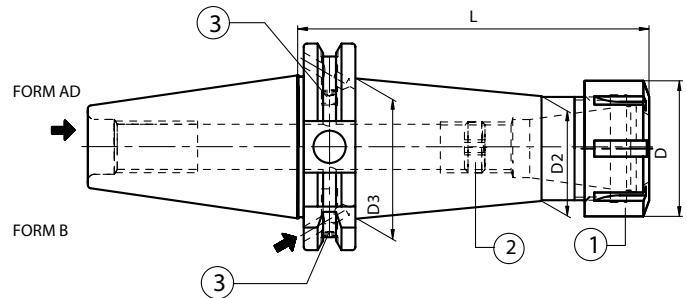

DIN 6499



Code N.	Description	ISO	ER	D	L	D2	D3	
EXTENDED H160	214-31359	TC40H160ER16 AD+B	40	16	32	160	22	32
	214-31345	TC40H160ER25 AD+B	40	25	42	160	32	42
	214-31346	TC40H160ER32 AD+B	40	32	50	160	40	50
	214-31366	TC40H160ER40 AD+B	40	40	63	160	50	50
	214-31367	TC50H160ER16 AD+B	50	16	32	160	22	32
	214-31368	TC50H160ER25 AD+B	50	25	42	160	32	42
	214-31337	TC50H160ER32 AD+B	50	32	50	160	40	50
	214-31340	TC50H160ER40 AD+B	50	40	63	160	50	63
H200	214-31369	TC40H200ER16 AD+B	40	16	32	200	22	32
	214-31370	TC40H200ER25 AD+B	40	25	42	200	32	42
	214-31371	TC40H200ER32 AD+B	40	32	50	200	40	50
	214-31372	TC40H200ER40 AD+B	40	40	63	200	50	50
	214-31373	TC50H200ER16 AD+B	50	16	32	200	22	32
	214-31374	TC50H200ER25 AD+B	50	25	42	200	32	42
	214-31375	TC50H200ER32 AD+B	50	32	50	200	40	50
	214-31376	TC50H200ER40 AD+B	50	40	63	200	50	63

Ersatzteile / Spare parts / Pieces detachees / Componenti

Tape	Screw	Quantity
		
ISO40	811-103009	2
ISO50	811-103009	2

ER	Nut	Stop screw
		
16	812-203005	811-303119
25	812-203001	811-303121
32	812-203002	811-303118
40	812-203003	811-303122

SPANNZANGENFUTTER ER TYP EXTRAKURZ
ER COLLET CHUCK WITH INSIDE NUT
MANDRINS COURTS A PINCES TYPE ER
MANDRINI PORTAPINZA TIPO ER EXTRACORTI

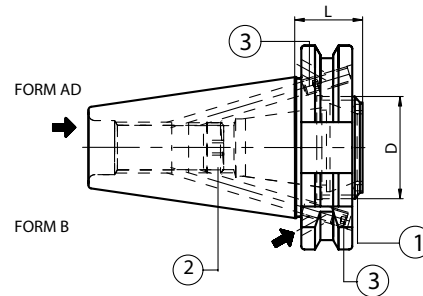

Code N.	Description	ISO	ER	D	L
214-31377	TC40H21ER25A- AD+B	40	25A	32	21
*264-31215	TC40H21ER32A	40	32A	40	21
214-31378	TC50H21ER32A- AD+B	50	32A	40	21

*Ausführung Form AD
 *Execution form AD
 *Forme AD
 *Forma AD

Ersatzteile / Spare parts / Pieces detachees / Componenti

Tape	Screw	Quantity
		
ISO 40	811-103009	2
ISO 50	811-103009	2

ER	Nut	Stop screw
		
25A	812-203057	811-303121
32A	812-203032	811-303118

DIN 69871 A

BOHRFUTTERAUFNAHMEN
ABORS FOR DRILL CHUCKS
ARBRES POUR MANDRINS DE PERCAGE
ATTACCO PER MANDRINI PORTAPUNTE

DIN 238

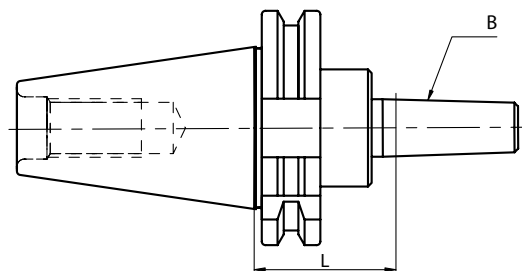

Code N.	Description	ISO	ER	D
216-31207	TC30H40B12	30	12	40
216-31208	TC30H40B16	30	16	40
216-31201	TC40H40B16	40	16	40
216-31202	TC40H40B18	40	18	40
216-31203	TC50H40B16	50	16	40
216-31204	TC50H40B18	50	18	40

**SPANNZANGENFUTTER EOC TYP
EOC COLLET CHUCK
MANDRINS A PINCES TYPE EOC
MANDRINI PORTAPINZA TIPO EOC**

DIN 6388

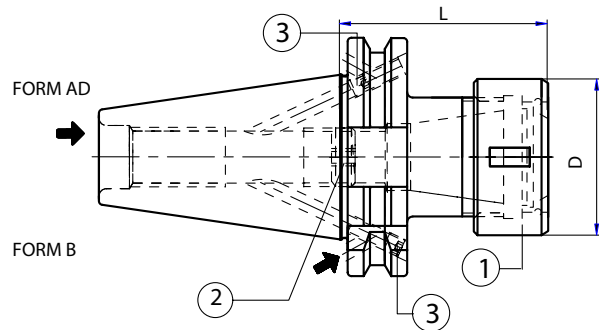

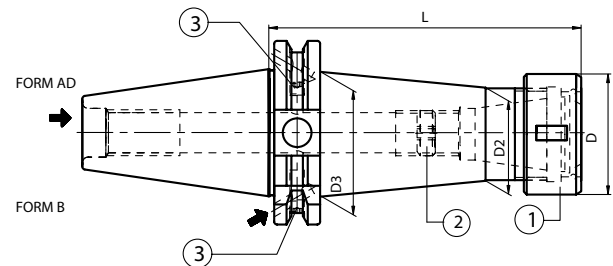

	Code N.	Description	ISO	EOC	D	L
STANDARD	214-11320	TC40H70EOC16 AD+B	40	16	43	70
	214-11321	TC40H70EOC25 AD+B	40	25	60	70
	214-11322	TC50H70EOC25 AD+B	50	25	60	70
	214-11323	TC50H80EOC32 AD+B	50	32	72	80



	Code N.	Description	ISO	EOC	D	L	D2	D3
EXTENDED	214-11324	TC40H130EOC16 AD+B	40	16	43	130	33	40
	214-11325	TC40H130EOC25 AD+B	40	25	60	130	48	49
	214-11326	TC50H130EOC25 AD+B	50	25	60	130	48	58
	214-11327	TC50H130EOC32 AD+B	50	32	72	130	60	62

Ersatzteile / Spare parts / Pieces detachees / Componenti

Tape	Screw	Quantity
		
ISO 40	811-103009	2
ISO 50	811-103009	2

EOC	Nut	Stop screw
		
16	812-202050	811-303121
25	812-202070	811-303123
32	812-202080	811-303123

**KRAFTSPANNFUTTER
MILLING CHUCK
MANDRINS A FORT SERRAGE
MANDRINI A FORTE SERRAGGIO**

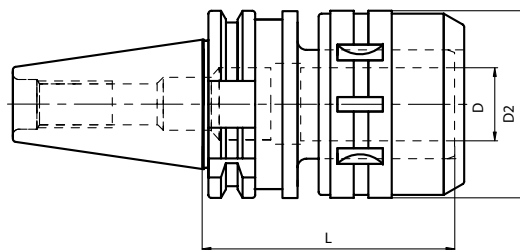

Code N.	Description	ISO	D	D2	L
214-01301	TC40H105C20	40	20	54	105
214-01302	TC40H105C32	40	32	72	105
214-01303	TC40H135C32	40	32	72	135
214-01304	TC50H105C20	50	20	54	105
214-01305	TC50H105C32	50	32	72	105
214-01306	TC50H135C32	50	32	72	135

DIN 69871 AD/B

**HYDRO-DEHNSPANNFUTTER FÜR WERKZEUGE MIT ZYLINDERSCHAFT
HYDRO-EXPANSION CHUCKS FOR TOOLS WITH CYLINDRICAL SHANK
MANDRINS HYDRO-EXPANSIBLES POUR OUTIL A QUEUE CYLINDRIQUE
MANDRINI IDRAULICI PER UTENSILI ATTACCO CILINDRICO**

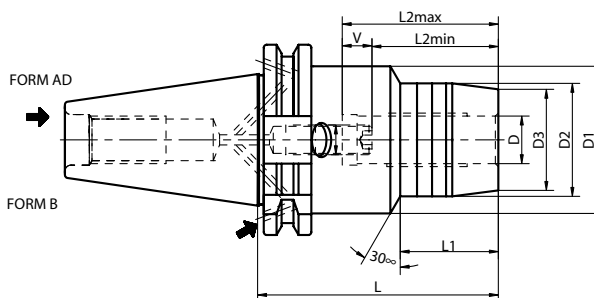

Code N.	Description	ISO	D	D1	D2	D3	L	L1	L2 min	L2 max	V	M
252-11205	TC40H80G06-WO AD+B	40	6	49.5	26	22	80.5	29.5	27.5	37.5	10	M5
252-11206	TC40H80G08-WO AD+B	40	8	49.5	28	24	80.5	30	27.5	37.5	10	M6
252-11207	TC40H80G10-WO AD+B	40	10	49.5	30	26	80.5	31	32.5	42.5	10	M8x1
252-11201	TC40H80G12-WO AD+B	40	12	49.5	32	28	80.5	31.5	37.5	47.5	10	M10x1
252-11208	TC40H80G16-WO AD+B	40	16	49.5	38	34	80.5	33	42.5	52.5	10	M10x1
252-11202	TC40H80G20-WO AD+B	40	20	49.5	42	38	80.5	34	42.5	52.5	10	M10x1
252-11209	TC40H80G25-WO AD+B	40	25	66	55	53	80.5	22	51	61	10	M16x1
252-11210	TC40H80G32-WO AD+B	40	32	80	63	60	80.5	25.5	55	65	10	M16x1
252-11203	TC50H80G20-WO AD+B	50	20	49.5	42	38	80.5	34	42.5	52.5	10	M10x1
252-11204	TC50H80G32-WO AD+B	50	32	-	72	56	81	-	55	65	10	M16x1

Suitable only for clamping the tools with straight shank DIN 1835A.
Do not clamp end mills with shank whistle-notch (DIN 1835E).
Do not carry out clamping action without the tool.

Adatti solo per utensili con gambo cilindrico DIN 1835A.
Non bloccare le frese con attacco whistle-notch (DIN 1835E).
Evitare la chiusura del mandrino, senza l'utensile nel foro.

**NC-BOHRFUTTER
UNIVERSAL DRILL CHUCKS
MANDRINS UNIVERSELS DE PERCAGE
MANDRINI PORTAPUNTE INTEGRALI**

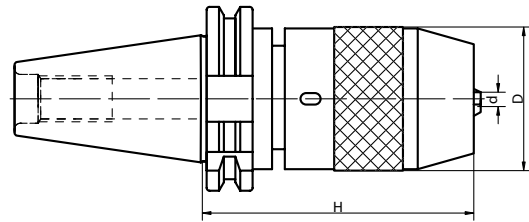

Code N.	Description	ISO	H	D	Clamping capacity	Wrench
252-11211	TC40H95R1-13	40	95	50	1-13	816-152001
252-11212	TC40H115R3-16	40	115	57	3-16	816-152002
252-11213	TC50H85R1-13	50	85	50	1-13	816-152001
252-11214	TC50H95R3-16	50	95	57	3-16	816-152002

RUNOUT ACCURACY 0.04 MM T.I.R.

Supplied with spanner wrench to allow the application of supplementary gripping torque.
DO NOT USE IN REVOLUTION IN COUNTER-CLOCKWISE DIRECTION.

PRECISIONE DI ROTAZIONE 0.04 MM

Per incrementare la forza di serraggio i mandrini sono forniti con chiave di bloccaggio.
NON DEVONO ESSERE USATI PER LAVORAZIONI CON ROTAZIONE A SINISTRA.

DIN 69871 AD/B

**NC-BOHRFUTTER FÜR RECHTS- UND LINKSLAUF
NC DRILL CHUCKS FOR LEFT AND RIGHT ROTATION
MANDRIN DE PERCAGE CNC POUR ROTATION GAUCHE-DROITE
MANDRINI PORTAPUNTE INTEGRALI PER ROTAZIONE DESTRA E SINISTRA**

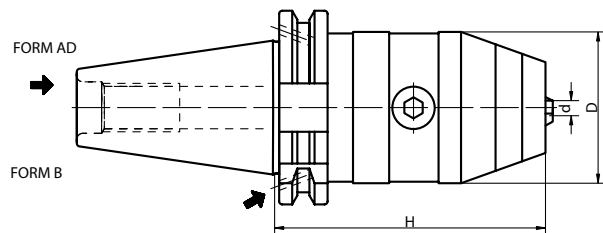

Code N.	Description	ISO	H	D	Clamping capacity	Wrench
252-11301	TC40H90R1-13X-AD/B	40	90	50	1-13	816-111024
252-11302	TC40H95R3-16X-AD/B	40	95	57	3-16	816-111025
252-11303	TC50H90R1-13X-AD/B	50	90	50	1-13	816-111024
252-11304	TC50H95R3-16X-AD/B	50	95	57	3-16	816-111025

RUNOUT ACCURACY 0.03 MM T.I.R.

Suitable for right and left rotation up to 7000 rpm. ○ With fine balancing and extra price, they can run up to 15000rpm.

PRECISIONE DI ROTAZIONE 0.03 MM.

Adatti per rotazione sia destra che sinistra, con velocità max di 7000 g/min. Velocità fino a 15000 g/min. sono ottenibili previa bilanciatura fine e con aumento di prezzo.

STELLHÜSENSAUFNAHMEN
MASTER SHANKS FOR ADJUSTABLE ADAPTORS
MANDRINS POUR DOUILLES REGLAGE
MANDRINI PER ASTUCCI REGISTABILI

DIN 6327

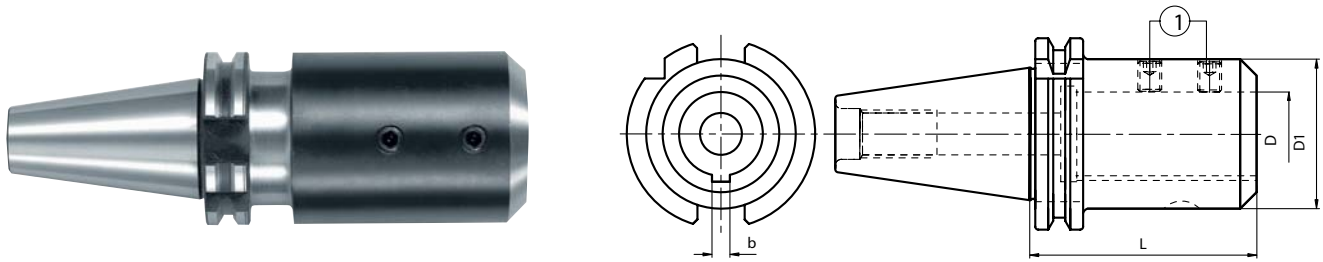

Code N.	Description	ISO	D	D1	L	b
211-11201	TC40H70D28TR	40	28	50	70	6
211-11202	TC40H120D36TR	40	36	63	120	8
211-11203	TC50H100D28TR	50	28	50	100	6
211-11204	TC50H100D36TR	50	36	63	100	8

Ersatzteile / Spare parts / Pieces detachees / Componenti

D	Screw
28	811-102027
36	811-102036

DIN 69871 A

ROHLINGE
BLANK TOOLHOLDER
BARRES D'ALEPAGE SEMI-FINIES
MANDRINI SEMILAVORATI A STELO TENERO

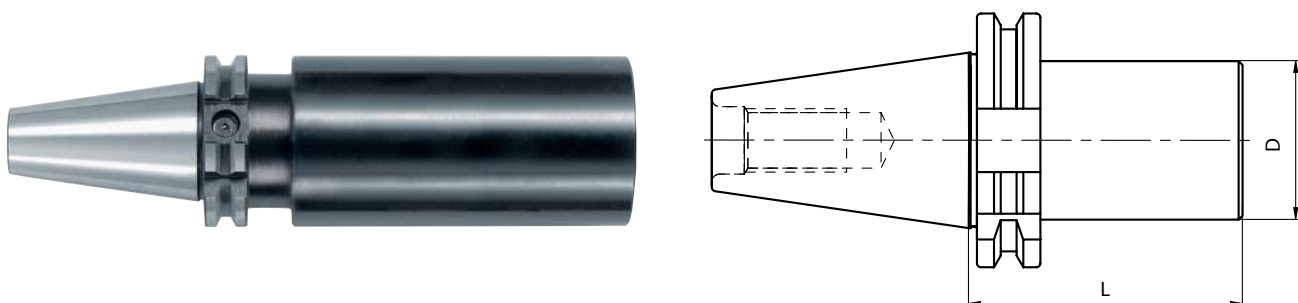

Code N.	Description	ISO	D	L
217-41204	TC40H160D40.5SM	40	40.5	160
217-41205	TC40H160D63.5SM	40	63.5	160
217-41206	TC40H250D63.5SM	40	63.5	250
217-41207	TC50H160D80SM	50	80	160
217-41208	TC50H200D80SM	50	80	200
217-41209	TC50H300D80SM	50	80	300

SPANNZANGENFUTTER TYP ER OHNE MITNEHMERNUTE
ER COLLET CHUCK WITHOUT DRIVING SLOTS
MANDRINS PORTE-PINCE-ENTRAINEMENT SANS CRANS
MANDRINI PORTAPINZA TIPO ER SENZA TACCHE DI TRASCINAMENTO

DIN 6499

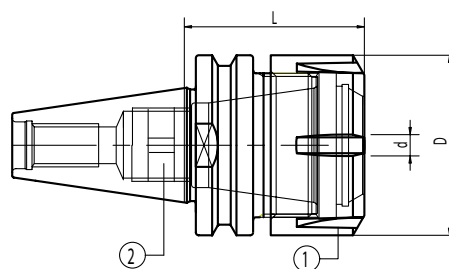

Code N.	Description	ISO	ER	d	D	L	Nut type
214-31263NY	TEK30H60ER16DX	30	16	1-10	32	60	Right
217-90227NY	TEK30H50ER20DX	30	20	1-13	35	50	
217-90228NY	TEK30H50ER25DX	30	25	1-16	42	50	
214-31240NY	TEK30H50ER32DX	30	32	2-20	50	50	
214-31266NY	TEK30H65ER32DX	30	32	2-20	50	65	
214-31275NY	TEK30H59.2ER40DX	30	40	3-30	63	59.2	
214-31262NY	TEK30H65ER40DX	30	40	3-30	63	65	Left
214-31271NY	TEK30H50ER32SX	30	32	2-20	50	50	
214-31276NY	TEK30H59.2ER40SX	40	40	3-30	63	59.2	Right
264-31209NY	TEK40H50ER16DX	40	16	1-10	32	50	
264-31210NY	TEK40H50ER20DX	40	20	1-13	35	50	
217-90398NY	TEK40H55ER25DX	40	25	1-16	42	55	
214-31277NY	TEK40H70ER32DX	40	32	2-20	50	70	Left
264-31211NY	TEK40H70ER40DX	40	40	3-30	63	70	
214-31270NY	TEK40H70ER32SX	40	32	2-20	50	70	
264-31212NY	TEK40H70ER40SX	40	40	3-30	63	70	

AUFSTECKFRÄSDORNE FÜR SCHEIBENFRÄSER OHNE MITNEHMERKERBE
MILLING CHUCKS WITHOUT DRIVING SLOTS
MANDRINS PORTE-FRAISES-ENTRAINEMENT SANS CRANS
MANDRINI PORTAFRESE A DISCO SENZA TACCHE DI TRASCINAMENTO

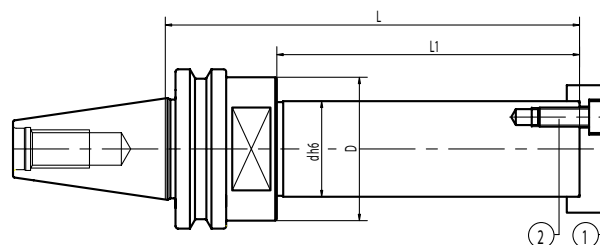

Code N.	Description	ISO	D	d (h6)	L	L1
267-90228NY	TEK30.L70.D30-FDL	30	45	30	105	70
217-90089NY	TEK30.L100.D30-FDL	30	45	30	135	100
217-90223NY	TEK30.L70.D35-FDL	30	45	35	105	70
217-90224NY	TEK30.L80.D35-FDL	30	45	35	115	80
217-90305NY	TEK30.L115.D35-FDL	30	45	35	150	115

All the toolholders are supplied with a superficial coating 'Niploy Process'. The same toolholders could be supplied also without this process. In this case, on the order, you have simply to write the reference number without 'NY' at the end.

Exe.: -214-31240NY (with Niploy Process) or 214-31240 (without Niploy Process)
 -217-90089NY (with Niploy Process) or 217-90089 (without Niploy Process)

N.B. Tutti i mandrini sopraelencati verranno forniti con trattamento superficiale NIPLOY PROCESS. Gli stessi possono essere forniti anche SENZA lo specifico trattamento: in questo caso, in fase di ordinazione, basta trascrivere il codice articolo senza „NY" finale.

Esempio: 214-31240NY (con Niploy Process) oppure 214-31240 (senza Niploy Process)
 217-90089NY (con Niploy Process) oppure 217-90089 (senza Niploy Process)

GEWINDESCHNEID-SCHNELLWECHSELFUTTER MIT LÄNGENAUSGLEICH
TENSION AND COMPRESSION TAPPING HEAD
MANDRINS DE TARAUDAGE A CHANGEMENT RAPIDE A DOUBLE USAGE
MASCHIATORI A DOPPIA COMPENSAZIONE

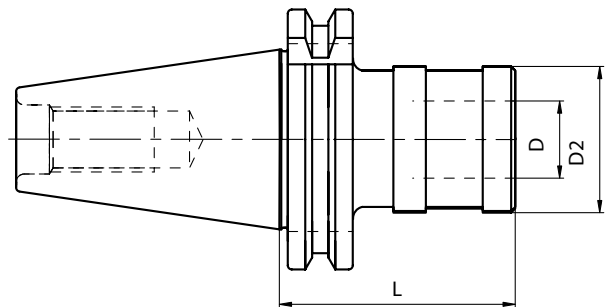

Code N.	Description	ISO	SIZE	Top range	PRESS.	EXT.	D	D2	L
M3008	TC30H60GR1.DC	30	1	M3-M12	9	9	19	38	60
M3009	TC30H101GR2.DC	30	2	M6-M20	15	15	31	53	101
M3010	TC40H60GR1.DC	40	1	M3-M12	9	9	19	38	60
M3110	TC40H92GR2.DC	40	2	M6-M20	15	15	31	53	92
M3210	TC40H138GR3.DC	40	3	M14-M33	24	24	48	78	138
M3030	TC50H62GR1.DC	50	1	M3-M12	9	9	19	38	62
M3130	TC50H83GR2.DC	50	2	M6-M20	15	15	31	53	83
M3230	TC50H133GR3.DC	50	3	M14-M33	24	24	48	78	133

DIN 69871 A

GEWINDESCHNEID-SCHNELLWECHSELFUTTER OHNE LÄNGENAUSGLEICH
SOLID TAPPING HEAD
MANDRINS DE TARAUDAGE A CHANGEMENT RAPIDE SANS COMPENSATION
MASCHIATORI RIGIDI SENZA COMPENSAZIONE

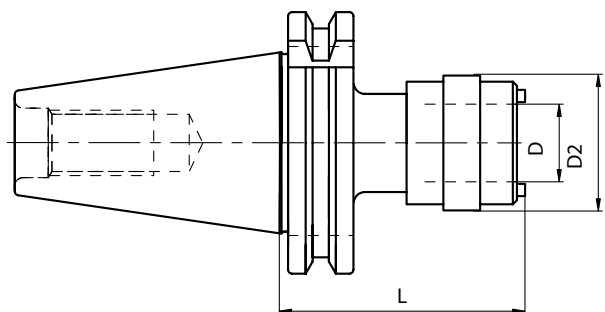

Code N.	Description	ISO	SIZE	Top range	D	D2	L
M5010	TC30H59GR1.SC	30	1	M3-M12	19	33	59
M5030	TC30H82GR2.SC	30	2	M6-M20	31	50	82
M5020	TC40H59GR1.SC	40	1	M3-M12	19	33	59
M5040	TC40H82GR2.SC	40	2	M6-M20	31	50	82

